



Air conditioner

User manual

AC***TNXDKG

- Thank you for purchasing this Samsung air conditioner.
- Before operating this unit, please read this user manual carefully and retain it for future reference.



SAMSUNG





Contents

Safety Information	4
Safety Information	4
At a Glance	15
Indoor Unit Overview	15
Display	15
Remote Control Overview	16
Replacing the remote control batteries • Storing the remote control	17
Remote Control Operation	18
Operation modes • Controlling temperature • Controlling fan speed	18
Controlling air flow direction	19
Smart Features	20
Power Smart Features	20
Wind-Free Cooling function	20
Auto mode • Cool mode	22
Dry mode • Fan mode	23
Heat mode	24
Variety Smart Features	25
Turbo function	25
Quiet function • Beep sound function	26
Display lighting function • Controlling the indoor units individually	27
Clean function	28
Clearing the filter-cleaning reminder • Controlling the air flow direction individually	29
Energy-Saving Features	30
Timed on/Timed off function	30
good'sleep function	31
Cleaning and Maintenance	32
Schedule	32
Cleaning	33
Maintaining the Air Conditioner	37
Internal protections via the unit control system	38





Appendix	39
Troubleshooting	39
Operation Ranges	42
Information about Refrigerant	42
Important information: regulation regarding the refrigerant used	42
Technical Specifications	43



***Correct Disposal of This Product
(Waste Electrical & Electronic Equipment)***

(Applicable in countries with separate collection systems)

This marking on the product, accessories or literature indicates that the product and its electronic accessories (e.g. charger, headset, USB cable) should not be disposed of with other household waste at the end of their working life. To prevent possible harm to the environment or human health from uncontrolled waste disposal, please separate these items from other types of waste and recycle them responsibly to promote the sustainable reuse of material resources.

Household users should contact either the retailer where they purchased this product, or their local government office, for details of where and how they can take these items for environmentally safe recycling.

Business users should contact their supplier and check the terms and conditions of the purchase contract. This product and its electronic accessories should not be mixed with other commercial wastes for disposal.



Correct disposal of batteries in this product

This marking on the battery, manual or packaging indicates that the batteries in this product should not be disposed of with other household waste at the end of their working life. Where marked, the chemical symbols Hg, Cd or Pb indicate that the battery contains mercury, cadmium or lead above the reference levels in EC Directive 2006/66.

For information on Samsung's environmental commitments and product-specific regulatory obligations, e.g. REACH, WEEE, Batteries, visit : samsung.com/uk/aboutsamsung/samsungelectronics/corporatecitizenship/data_corner.html





Safety Information

WARNING: Read This Manual

Read and follow all safety information and instructions before installation, use, or maintenance of this appliance. Incorrect installation, use, or maintenance of this appliance can result in death, serious injury, or property damage. Keep these instructions with this appliance. This manual is subject to change. For the latest version, visit www.samsung.com.

Because the instructions in this manual cover various models, the characteristics of your air conditioner may differ slightly from those described. If you have any questions, please contact your service provider or visit www.samsung.com.

Notices and notes

To make you aware of safety messages and highlighted information, we use the following notices and notes throughout this manual:

WARNING

Hazards or unsafe practices that may result in severe personal injury or death.

CAUTION

Hazards or unsafe practices that may result in minor personal injury or property damage.

IMPORTANT

Information of special interest

NOTE

Supplementary information that may be useful





WARNING: Low burning velocity material
(This appliance is filled with R-32.)



The user and installer guides should be read carefully.



The user and installer guides should be read carefully.



The service guide should be read carefully.

FOR GENERAL

This appliance is not intended for use by persons (including children) with reduced physical, sensory or mental capabilities, or lack of experience and knowledge, unless they have been given supervision or instruction concerning use of the appliance by a person responsible for their safety. Children should be supervised to ensure that they do not play with the appliance.

For use in Europe : This appliance can be used by children aged from 8 years and above and persons with reduced physical, sensory or mental capabilities or lack of experience and knowledge if they have been given supervision or instruction concerning use of the appliance in a safe way and understand the hazards involved. Children shall not play with the appliance. Cleaning and user maintenance shall not be made by children without supervision.

IMPORTANT

To perform its antimicrobial function this product has been treated with the biocide substance Silver zinc zeolite.





Safety Information

FOR INSTALLATION



WARNING

Use the power line with the power specifications of the product or higher and use the power line for this appliance only. In addition, do not use an extension line.

- Extending the power line may result in electric shock or fire.
- Do not use an electric transformer. This may result in electric shock or fire.
- If the voltage/frequency/rated current condition is different, it may cause fire.

The installation of this appliance must be performed by a qualified technician or service company.

- Failing to do so may result in electric shock, fire, explosion, problems with the product, or injury and may also void warranty on the installed product.

Install an Isolation Switch next to the Air Conditioner (but not on the panels of the Air Conditioner) and circuit breaker dedicated to the air conditioner.

- Failing to do so may result in electric shock or fire.

Fix the outdoor unit firmly so that the electric part of the outdoor unit is not exposed.

- Failing to do so may result in electric shock, fire, explosion, or problems with the product.

Do not install this appliance near a heater, or inflammable material. Do not install this appliance in a humid, oily or dusty location, in a location exposed to direct sunlight and water (rain drops). Do not install this appliance in a location where gas may leak.

- This may result in electric shock or fire.





Never install the outdoor unit in a location such as on a high external wall where it could fall.

- If the outdoor unit falls, it may result in injury, death or property damage.

This appliance must be properly grounded. Do not ground the appliance to a gas pipe, plastic, water pipe, or telephone line.

- Failing to do so may result in electric shock, fire, and explosion, or other problems with the product.
- Make sure to use a socket-outlet with ground.



CAUTION

Please cover the air conditioner with PE BAG after installation, and remove it when you start to run air conditioner.

Install your appliance on a level and hard floor that can support its weight.

- Failing to do so may result in abnormal vibrations, noise, or problems with the product.

Install the drain hose properly so that water drains correctly.

- Failing to do so may result in water overflowing and property damage. Avoid adding drain to waste pipes as odours may arise in the future.

The product shall be stored in a room with no ignition sources (e.g. open flames, gas appliance, electric heater, etc.).

- Note that the refrigerant has no odour.

When installing the outdoor unit, make sure to connect the drain hose so that draining is performed correctly.

- The water generated during the heating operation in the outdoor unit may overflow and result in property damage. In particular, in winter, if a block of ice falls, it may result in injury, death or property damage.



Safety Information

Do not install the product in a place where thermo-hygrostat is needed (such as server room, machinery room, computer room, etc.)

- Those places do not provide guaranteed operation condition of the product therefore performance can be poor in these places.

FOR POWER SUPPLY



WARNING

When the circuit breaker is damaged, contact your nearest service centre.

Do not pull or excessively bend the power line. Do not twist or tie the power line. Do not hook the power line over a metal object, place a heavy object on the power line, insert the power line between objects, or push the power line into the space behind the appliance.

- This may result in electric shock or fire.

If the supply cord is damaged, it must be replaced by the manufacturer, its service agent or similarly qualified persons in order to avoid a hazard.



CAUTION

When not using the air conditioner for a long period of time or during a thunder/lightning storm, cut the power at the circuit breaker.

- Failing to do so may result in electric shock or fire.





FOR USING

WARNING

If the appliance is flooded, please contact your nearest service centre.

- Failing to do so may result in electric shock or fire.

If the appliance generates a strange noise, a burning smell or smoke, cut off the power supply immediately and contact the nearest service centre.

- Failing to do so may result in electric shock or fire.

In case of a malfunction, immediately stop operation of the air conditioner and disconnect the entire power system. Then consult the authorized service personnel.

In the event of a gas leak (such as propane gas, LP gas, etc.), ventilate immediately without touching the power line. Do not touch the appliance or power line.

- Do not use a ventilating fan.
- A spark may result in an explosion or fire.

To reinstall the air conditioner, please contact your nearest service centre.

- Failing to do so may result in problems with the product, water leakage, electric shock, or fire.
- Delivery service for the product is not provided. If you reinstall the product in another location, additional construction expenses and an installation fee will be charged.
- Especially, when you wish to install the product in an unusual location such as in an industrial area or near the seaside where it is exposed to salt in the air, please contact your nearest service centre.





Safety Information

- In the event of a service issue, please refer to the troubleshooting guide of the relevant supporting technical manuals. It is recommended that a skilled service technician be contacted for support. Should urgent support be required then, using the information provided, contact the local Samsung office via email or telephone so that support can be initiated via our approved service centres (ASC'S) within 24hrs.

Do not touch the circuit breaker with wet hands.

- This may result in electric shock.

Do not turn the air conditioner off with the circuit breaker while it is operating.

- Turning the air conditioner off and then on again with the circuit breaker may cause a spark and result in electric shock or fire.

After unpacking the air conditioner, keep all packaging materials well out of the reach of children, as packaging materials can be dangerous to children.

- If a child places a bag over its head, it may result in suffocation.

Do not touch the front panel with your hands or fingers during the heating operation.

- This may result in electric shock or burns.

Do not insert your fingers or foreign substances into the air inlet/outlet of the air conditioner.

- Take special care that children do not injure themselves by inserting their fingers into the product.

Do not strike or pull the air conditioner with excessive force.

- This may result in fire, injury, or problems with the product.





Do not place an object near the outdoor unit that allows children to climb onto the machine.

- This may result in children seriously injuring themselves.

Do not use this air conditioner for long periods of time in badly ventilated locations or near infirm people.

- Since this may be dangerous due to a lack of oxygen, open a window at least once an hour.

Do not use means to accelerate the defrost operation or to clean, other than those recommended by Samsung.

Do not pierce or burn.

Be aware that refrigerants may not contain an odour.

If any foreign substance such as water has entered the appliance, cut off the power supply and contact the nearest service centre.

- Failing to do so may result in electric shock or fire.

Do not attempt to repair, disassemble, or modify the appliance yourself.

- Do not use any fuse (such as copper, steel wire, etc.) other than the standard fuse.
- Failing to do so may result in electric shock, fire, problems with the product, or injury.

CAUTION

Do not place objects or devices under the indoor unit.

- Water dripping from the indoor unit may result in fire or property damage.

Check that the installation frame of the outdoor unit is not broken at least once a year.

- Failing to do so may result in injury, death or property damage.



Safety Information

To prevent personal injury, make sure that you change the directions of the horizontal airflow blades after stopping the movements of the vertical airflow blade. (In case of adjusting the horizontal airflow manually)

When the air conditioner does not operate properly for cooling or heating, there is a possibility of refrigerant leakage. If any leakage, stop operation, ventilate the room, and consult your dealer immediately for recharging refrigerant.

The refrigerant is not harmful. However, if it comes in contact with fire, it may generate harmful gases and there is risk of fire.

During transportation of the indoor unit, the pipe lines shall be covered with brackets for protection. Do not move the product with holding the pipe lines.

- It may cause gas leakage.

Do not install the product in a ship or a vehicle (such as a campervan).

- Salt, vibration or other environmental factor may cause the product malfunction, electric shock or fire.

Do not stand on top of the appliance or place objects (such as laundry, lighted candles, lighted cigarettes, dishes, chemicals, metal objects, etc.) on the appliance.

- This may result in electric shock, fire, problems with the product, or injury.

Do not operate the appliance with wet hands.

- This may result in electric shock.

Do not spray volatile material such as insecticide onto the surface of the appliance.

- As well as being harmful to humans, it may also result in electric shock, fire or problems with the product.



Do not drink the water from the air conditioner.

- The water may be harmful to humans.

Do not hit, shake, drop, or attempt to disassemble the remote control.

When replacing the remote control batteries, keep them out of the reach of infants.

- If an infant eats batteries, contact a doctor immediately.

When replacing the remote control batteries, be careful not to get the battery fluid on your skin.

- Battery fluid is harmful to humans.

Do not touch the pipes connected with the product.

- This may result in burns or injury.

Do not cut or burn the refrigerant container or pipings.

Do not point the air direction to the fireplace or heater.

Do not use this air conditioner to preserve precision equipment, food, animals, plants or cosmetics, or for any other unusual purposes.

- This may result in property damage.

Avoid directly exposing humans, animals or plants to the airflow from the air conditioner for long periods of time.

- This may result in harm to humans, animals or plants.



Safety Information

FOR CLEANING



WARNING

Do not clean the appliance by spraying water directly onto it. Do not use benzene, thinner, alcohol or acetone to clean the appliance.

- This may result in discolouration, deformation, damage, electric shock or fire.

Before cleaning or performing maintenance, cut off the power supply and wait until the fan stops.

- Failing to do so may result in electric shock or fire.



CAUTION

Take care when cleaning the surface of the heat exchanger of the outdoor unit since it has sharp edges.

- This should be done by a qualified technician. Please contact your installer or service centre.

Do not clean the inside of the air conditioner by yourself.

- For cleaning inside the appliance, contact your nearest service centre.
- When cleaning the filter, refer to the descriptions in the 'Cleaning' section.
- Failing to do so may result in damage, electric shock or fire.
- Make sure to prevent any injury from sharp edges of the surface when handling the heat exchanger.





Indoor Unit Overview

The appearance of the actual product may differ slightly from the image below.

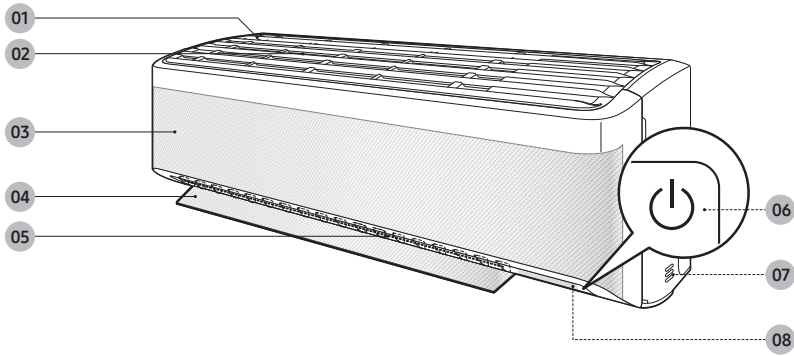

- 01 Air intake
- 02 Air filter
- 03 Wind-Free panel
- 04 Airflow blade (up and down)
- 05 Airflow blade (left and right)
- 06 Power button/Remote control receiver
- 07 Room temperature sensor
- 08 Display

At a Glance

Display

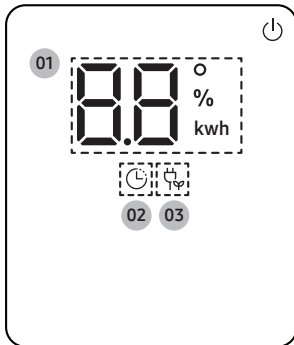

- 01 Temperature indicator (numeric)
Filter reset indicator (F)
Auto clean indicator (A)
Defrost indicator (DF)
- 02 Timer indicator
good'sleep indicator
- 03 Eco indicator



Remote Control Overview

Most operating instructions in this manual require using the remote control.

At a Glance

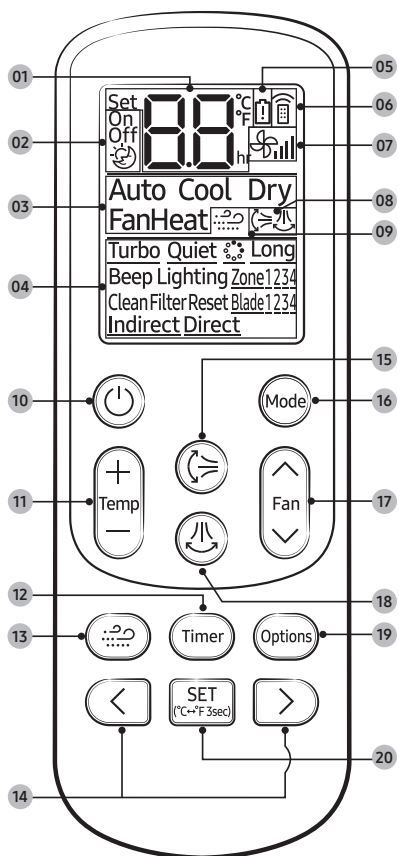

- 01 Set temperature / Timer indicator
- 02 Timer option indicator
- 03 Operation mode indicator
- 04 Options indicator
- 05 Low battery indicator
- 06 Signal transmission indicator
- 07 Fan speed indicator
- 08 Air flow direction indicator
- 09 Wind-Free indicator
- 10 Power button
- 11 Temperature button
- 12 Timer button
- 13 Wind-Free button
- 14 Direction button / Selection button
- 15 Vertical air swing button
- 16 Mode button
- 17 Fan speed button
- 18 Horizontal air swing button
- 19 Options button
- 20 SET button/Temperature type button(°C ↔ °F)

NOTE

- To select a function, point the remote control to the remote control sensor on an indoor unit.
- Although **Ionizer** (☼☼☼), **Long**, **Indirect**, **Direct** is displayed on the remote control display, it is not available on this model.
- If you turn off the remote control and then turn it on, the settings of Timed on/off and other options that you set previously are cancelled. Air flow direction setting will not be cancelled.
- If the indoor unit number (Zone 1 to Zone 4) that you select on the remote control display does not match the indoor unit (default: Indoor Unit 1) pointed by the remote control, the indoor unit will not operate.
- If you press a button on the remote control near a strong light such as a compact fluorescent lamp or neon sign, the air conditioner may not operate. In this case, move close to the indoor unit, and then operate the remote control.
- If other appliances respond to the remote control, contact a service centre.



Replacing the remote control batteries

When the  icon appears in the remote control display, replace the batteries with new ones. Two 1.5V AAA type batteries are required.

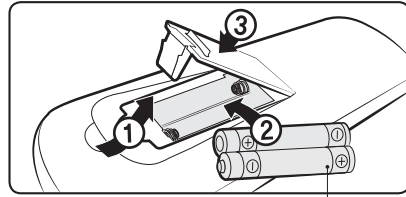

two 1.5V AAA type batteries

At a Glance

Storing the remote control

If the remote control will not be used for an extended period of time, store it in the remote control holder with the batteries removed.

CAUTION

- Make sure that water does not come into the remote control.

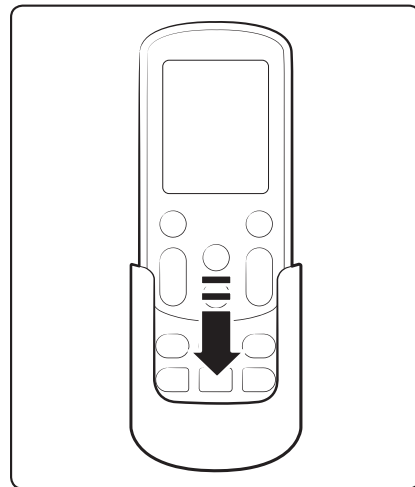

Remote Control Operation

You can use the air conditioner easily by selecting a mode and then by controlling the temperature, fan speed, and air flow direction.

At a Glance



Operation modes

You can change the current mode between Auto, Cool, Dry, Fan, and Heat by pressing the **Mode** button.

Controlling temperature

You can control the temperature in each mode as follows:

Mode	Temperature control
Auto/Cool/Dry	Adjust by 1 °C between 18 °C and 30 °C.
Fan	You cannot control the temperature.
Heat	Adjust by 1 °C between 16 °C and 30 °C.

You can switch between Celsius and Fahrenheit indications on the remote control.



▶ Press and hold for 3 or more seconds.

NOTE

- The temperature indications on the indoor unit are not switched.
- This function is canceled when the remote control batteries are replaced. In this case, run this function again.

Controlling fan speed

You can select the following fan speeds in each mode:

Mode	Available fan speeds
Auto/Dry	☼ (Auto)
Cool/Heat	☼ (Auto), ☼ (Low), ☼ (Med), ☼ (High)
Fan	☼ (Low), ☼ (Med), ☼ (High)

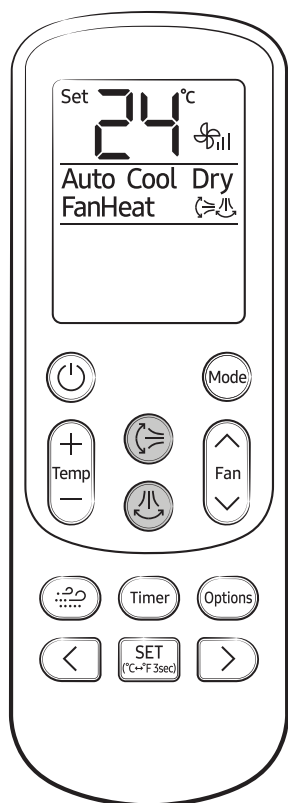



Controlling air flow direction

Selecting air flow direction

You can change air flow direction to either vertical or horizontal.

In operation ►  or 

NOTE

- To lock a specific air flow direction, press either the  or  button when the air flow blades are in the intended position.

Horizontal air flow (manual)

Keep the horizontal air flow in a constant direction by changing the directions of the horizontal air flow blades manually.

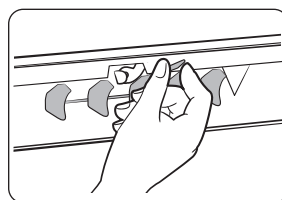

NOTE

- Although you press the  button, this function does not work.

CAUTION

- To prevent personal injury, make sure that you change the directions of the horizontal air flow blades after stopping the movements of the vertical air flow blade.



Power Smart Features

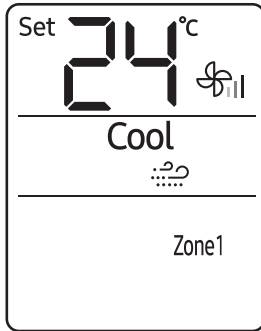

Wind-Free Cooling function

Use the Wind-Free Cooling function to enjoy mild cool breeze exuding from fine holes on the Wind-Free panel with the air flow blade closed, instead of getting cool wind directly. The automated control of the temperature and fan speed according to the indoor temperatures keeps your room cool and pleasant.

In the Cool, Dry, or Fan mode ▶ 

NOTE

- To cancel this function, press the  button again.
- If the Wind-Free Cooling function is cancelled, the air conditioner returns to the original fan speed.
- You can adjust the set temperature during the Wind-Free Cooling function, and recommended set temperatures are 24 to 26 °C. However, you cannot change the set temperature in the Fan mode.
- You can use the Wind-Free Cooling function when the Cool, Dry, or Fan mode is running.
- If the room temperature goes high because of rise of external temperature, heat from cooking, or other reason, operate the Wind-Free Cooling function after operating in the Cool mode.
- If you select the Wind-free Cooling function in the Fan mode, the compressor stops working so that cool air does not come out. However, mild breeze comes out and starts to clean the air in the room.





- During the Wind-Free Cooling operation, the cold air may be intermittently weakened depending on the temperature and humidity in the room. But the Wind-Free air currents are maintained and the weakened cold air is immediately recovered, consequently keeping the room comfortable. (During the Wind-Free Cooling operation, the air flow blades may open to control the indoor air currents smoothly, depending on the installation settings. In this case, as soon as the indoor temperature and humidity change, the air flow blades are closed and the Wind-Free Cooling operation restarts. For more information on the installation settings, see "Setting the indoor unit addresses and the installation options" in the installation manual of the indoor unit.)

Change of the air flow blade by temperature and humidity			
Indoor temperature and humidity	Low	High	
		Breeze is blown via the micro holes on the air flow blades	Breeze is blown via the micro holes on the air flow blades
Air flow blade	Closed	Closed (default)	Opened (according to setting)

- When the Wind-Free Cooling function runs while sleeping, you may feel cold air if the air conditioner is installed over the bed. In this case, set the desired temperature higher than the normal setting temperature.
- If you select the Wind-Free Cooling function while such functions as Turbo, Quiet, an Air flow direction ((⊙), ⊕) or good'sleep are running, these functions are cancelled.





Power Smart Features

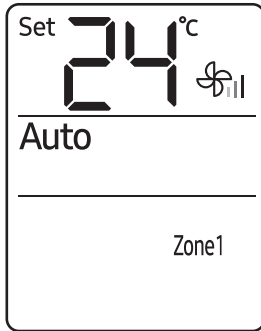

Auto mode

Use the Auto mode when you want the air conditioner to automatically control the mode (Heat or Cool). The air conditioner will provide the most comfortable atmosphere that it can.



NOTE

- You cannot change the fan speed.
- While the Cool mode is running, the air conditioner produces a strong cold air if there is a large difference between the set temperature and the current temperature. When the temperature difference becomes small, the air conditioner automatically changes the air flow direction to Wide and keeps the room at a comfortable temperature.

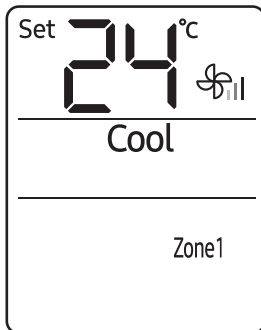

Cool mode

Use the Cool mode to stay cool in hot weather.



NOTE

- For comfort, keep the temperature difference between the indoor and outdoor air within 5°C in the Cool mode.
- To cool your room quickly, select a low temperature and a high fan speed.
- To save energy, select a high temperature and a low fan speed.
- As the indoor temperature approaches the set temperature, the compressor will operate at a low speed to save energy.



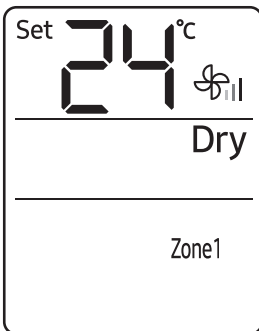

Dry mode

Use the Dry mode in rainy or humid weather.



NOTE

- You cannot change fan speed in the Dry mode.
- The greater the difference between the set temperature and the current temperature is, the greater the amount of air that is dehumidified is.

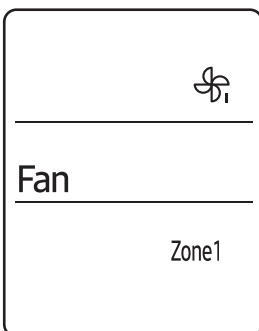

Fan mode

Use the Fan mode to run the air conditioner like a common fan. The air conditioner provides a natural breeze.



NOTE

- If the air conditioner will not be used for an extended period of time, dry the air conditioner by running it in the Fan mode for 3 or 4 hours.



Power Smart Features

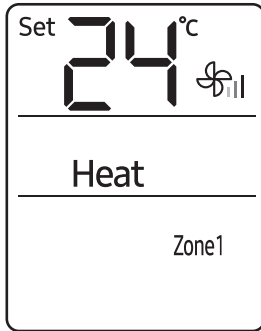

Heat mode

Use the Heat mode to stay warm.



NOTE

- While the air conditioner warms up, the fan may not operate for a while at the beginning to prevent cold wind.
- While the defrost function is running, the indoor unit provides no breeze to prevent cold wind.
- If the outdoor temperature is low and the humidity is high while the Heat mode is running, the heating performance of the air conditioner may decrease due to frost and ice that formed on the outdoor heat exchanger. When this condition happens, the air conditioner runs the defrost function for about 5 to 12 minutes to remove the frost and ice, and water steam is released from the outdoor unit.
- The operation time of the defrost function varies depending on the amount of the frost and ice and the humidity.
- While the defrost function is running, none of other functions will work, even if you select them on the remote control.





Variety Smart Features

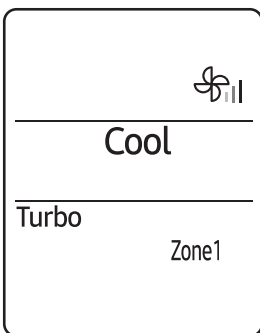

Turbo function

Use the Turbo function to provide intensive cooling or heating to sharply decrease or increase indoor temperature within 30 minutes.

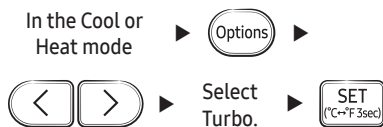

NOTE

- After 30-minute operation, the air conditioner automatically switches to standard the Cool or Heat mode.
- You can change air flow direction. Duct-type indoor units do not come with a vertical air flow direction.
- You cannot change set temperature or fan speed.
- If you select the Turbo function while such functions as Wind-Free Cooling, Quiet, or good'sleep are running, these functions are cancelled.



Variety Smart Features

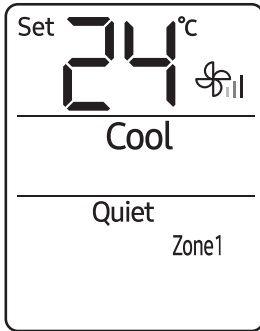

Quiet function

Use the Quiet function to reduce operating noise. You can select this function both in the Cool and Heat modes.

In the Cool or Heat mode ▶ Options ▶

< > ▶ Select Quiet. ▶ SET (°C/°F 3sec)

NOTE

- You can change set temperature and air flow direction.
- You cannot change the fan speed.
- If you select the Quiet function while such functions as Turbo, or good'sleep are running, these functions are cancelled.

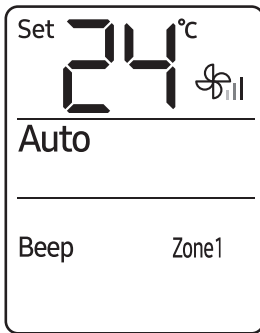

Beep sound function

Use the Beep sound function to turn on or off the beep sound that plays when you press a button on the remote control.

Options ▶ < > ▶ Select Beep. ▶ SET (°C/°F 3sec)



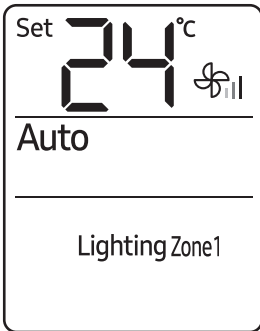

Display lighting function

Use the Display lighting function to turn on or off the lighting of the indoor unit display.

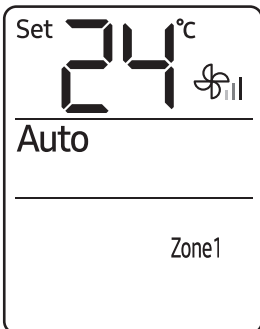

Controlling the indoor units individually

Use the Zone function to choose the indoor unit you want to operate individually. For example, select Zone 1 to control only the indoor unit 1.

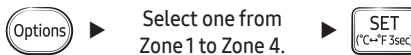

NOTE

- You can select either one or all of Zone 1 to Zone 4.
- The indoor unit numbers must be set by the installer: the installer sets a number on each indoor unit. To change the existing indoor unit numbers, contact a service centre.
- The current Zone function settings persist even if you change the current mode or you turn off and then turn on the remote control. The zone selection you made using the remote control is reset when the remote control batteries are replaced.



Variety Smart Features

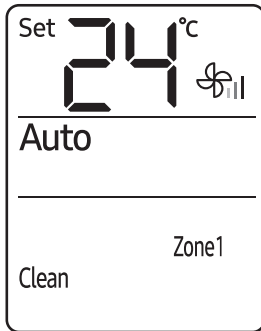

Clean function

Use the Clean function to remove moisture from the inside of the air conditioner for preventing propagation of fungi, bacteria, etc.



NOTE

- Depending on the condition of the indoor unit, the Clean operation stops after running for 30 seconds to 20 minutes.
- When the Clean Function is set, the indoor unit displays "Cl". When the Clean function is cancelled, the indoor unit displays nothing.
- You cannot use the Clean function after starting the Timed Off or good'sleep function.
- If you turn on the air conditioner and then turn it off within 20 seconds, the Clean function does not operate.
- When the air conditioner is turned off, the Clean function operates immediately. When it is turned on, the Clean function operates after it is stopped.
- Once the Clean function is started, it automatically continues to operate until it is cancelled.

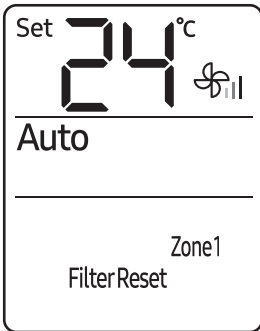

Clearing the filter-cleaning reminder

Use the Filter Reset function to reset the filter-cleaning reminder after cleaning or replacing the filter.

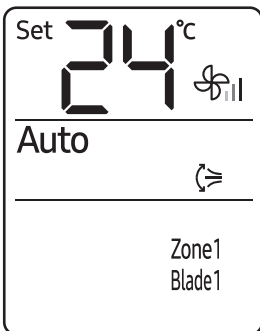
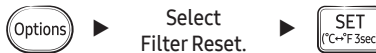

Controlling the air flow direction individually

Use the individual air-flow-direction control function to individually control the air flow directions of the air outlets.

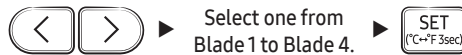

NOTE

- This function is available only on 4-way cassette air conditioners.
- You can select all or specific blades of indoor units 1 through 4.
- To cancel the selected air flow direction, press the button.
- If specific blades are selected, the button is disabled.
- The individual air flow direction control function, which is available on the 360 cassettes only, can be operated with a 360-cassette wireless remote control (AR-KH00E, AR-KH00U) only.





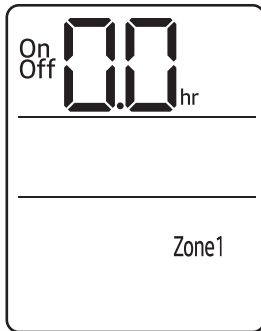

Energy-Saving Features



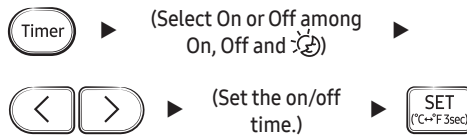

Timed on/Timed off function

Use the Timed on/Timed off to turn on or off the air conditioner after the time that you set.



- Press the  (Timer) button to change the current function between On, Off, and  (good'sleep).  (good'sleep) is displayed in the Cool and Heat mode only.

NOTE

- You can set a time between 0.5 and 24 hours. Set the time interval to 0.0 to cancel the Timed on/off function.
- After starting the Timed on function, you can change the mode and the set temperature. When you apply the Timed on/off function to the Fan mode, you cannot change the set temperature.
- You cannot set the same time for both of the Timed on and Timed off functions.
- If you press the  button when the remote control is off, On is displayed first on the remote control display; if you press the  button when the remote control is on, Off is displayed first.

Combining Timed on and Timed off

When the air conditioner is off	<p>Example) Timed on: 3 hours, Timed off: 5 hours</p> <ul style="list-style-type: none"> • The air conditioner turns on after 3 hours from the moment you start Timed on/off, remains on for 2 hours, then turns off automatically.
When the air conditioner is on	<p>Example) Timed on: 3 hours, Timed off: 1 hours</p> <ul style="list-style-type: none"> • The air conditioner turns off after 1 hour from the moment you start Timed on/off, then turns on after 2 hours from the moment it is turned off.



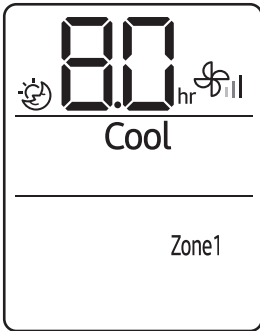

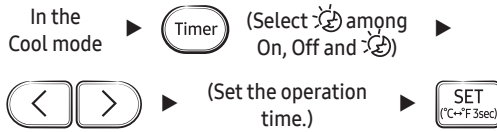

good'sleep function

Use the good'sleep function to get a good sleep at night and to save energy. You can select this function in the Cool mode.



- Press the  (Timer) button to change the current function between On, Off, and  (good'sleep).

NOTE

- Fan speed and air flow directions are automatically adjusted.
- You can adjust the set temperature by 1 °C between 18 °C and 30 °C .
- The recommended set temperature in good'sleep function is 25 to 27 °C.
- You can set the operation time to between 0.5 and 12 hours. Set the operation time to 0.0 to cancel the good'sleep function.
- The default operation time for the good'sleep function in the Cool mode is 8 hours. If the operation time is set to over 5 hours, the Wake up function begins 1 hour before the set time. The air conditioner stops automatically when the operation time expires.
- When the Timed on, Timed off, and good'sleep functions are overlapped, the air conditioner operates its timer with only the function that you have started most recently.
- If you select the good'sleep function while such functions as Wind-Free Cooling, Turbo, or Quiet are running, these functions are cancelled.



Schedule

Task	How often	By whom	Instruction
Run the Auto clean function.	As needed	Owner	"Auto clean function" on page 33.
Clean the filter.	Once every two weeks	Owner	"Cleaning the filter" on page 35.
Clean the Wind-Free panel	At least once a month	Owner	"Cleaning the Wind-Free panel" on page 36.
Clean the exterior of the indoor unit.	As needed	Owner	"Cleaning the outside of the indoor unit" on page 34.
Clean the exterior of the outdoor unit.	At least once a year	Owner	"Cleaning the heat exchanger on the outdoor unit" on page 34.
Replace the remote control batteries	As needed	Owner	"Replacing the remote control batteries" on page 17.
Apply corrosion inhibitor on outdoor unit. (Only if installed near salt water such as an ocean)	At least once a year	Qualified technician	Contact your service provider.
Clean inside the indoor or outdoor unit.	Once a year	Qualified technician	Contact your service provider.
Inspect the units, electrical connections, refrigerant tubes, and protections.	Once a year	Qualified technician	Contact your service provider.

Cleaning

Auto clean function

Use the Clean function to remove moisture from the inside of the air conditioner for preventing propagation of fungi, bacteria, etc.



NOTE

- Depending on the condition of the indoor unit, the Clean operation stops after running for 30 seconds to 20 minutes.
- When the Clean function is set, the Timer LED on the indoor unit blinks 3 times for 3 seconds (OFF → ON → OFF → ON → OFF → ON → OFF → returns to the previous state). When the Clean function is cancelled, the Timer LED on the indoor unit blinks once for 1 second (OFF → ON → OFF → returns to the previous state).
- You cannot use the Clean function after starting the Timed Off or good'sleep function.
- If you turn on the air conditioner and then turn it off within 20 seconds, the Clean function does not operate.
- When the air conditioner is turned off, the Clean function operates immediately. When it is turned on, the Clean function operates after it is stopped.
- Once the Clean function is started, it automatically continues to operate until it is cancelled.



Cleaning

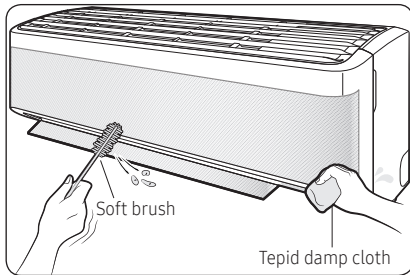

Cleaning the outside of the indoor unit

- 1 Turn off the air conditioner and wait until the fan stops.
- 2 Disconnect the power supply.
- 3 Use a soft brush or tepid damp cloth to clean the exterior.

WARNING

- Do not clean the appliance by spraying water directly onto it. Water entering the unit may result in electric shock or fire that could cause death, serious injury, or property damage:

CAUTION

- Do not use an alkaline detergent to clean the indoor unit display.
- Do not use sulphuric acid, hydrochloric acid, or organic solvents such as paint thinner, kerosene, acetone, benzene, or alcohol to clean the unit surfaces.

Cleaning the heat exchanger on the outdoor unit

- 1 Turn off the air conditioner and wait until the fan stops.
- 2 Disconnect the power supply.
- 3 Spray water on the heat exchanger to remove dust and other debris.

CAUTION

- Do not use sulphuric acid, hydrochloric acid, or organic solvents such as paint thinner, kerosene, acetone, benzene, or alcohol to clean the unit surfaces.
- If you need to inspect or clean the inside of the heat exchanger on the outdoor unit, contact a local service centre for help.





Cleaning the filter

Clean the air filter every two weeks or when the **F** (filter-cleaning reminder) appears on the indoor unit display. The time between cleanings may vary, depending on the usage and environmental conditions.

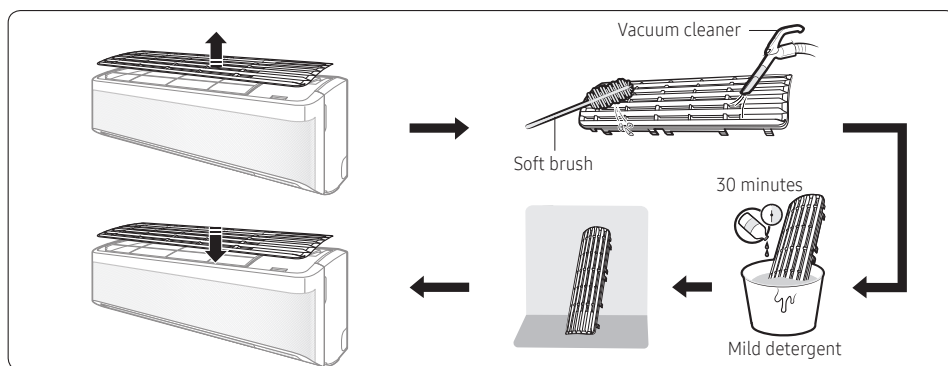

- 1 Slide the filter off of the unit.
- 2 Use a soft brush or vacuum cleaner to remove any dust or debris on the filter.
- 3 Soak the filter in a solution of water and mild detergent for 30 minutes.
- 4 Rinse the filter and let it air dry in a well-ventilated area that is out of direct sunlight.
- 5 Reinstall the filter.
- 6 Reset the filter-cleaning reminder:

In operation ► **Options** ► **<** **>** ► Select Filter Reset. ► **SET**

⚠ CAUTION

- Take care not to damage the filter during cleaning.
- Do not scrub the air filter with a hard-bristle brush or another cleaning utensil.
- Do not expose the air filter to direct sunlight when drying it.



Cleaning

Cleaning the Wind-Free panel

Clean the Wind-Free panel at least once a month.

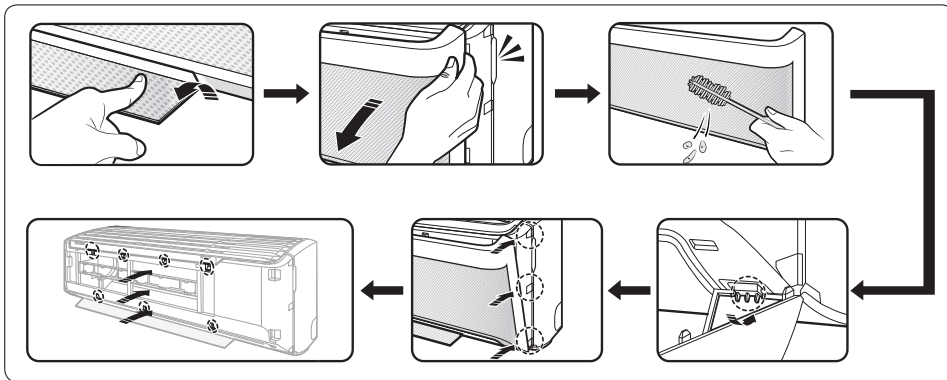

- 1 Pull the airflow blade open.
- 2 Hold and pull both sides of the Wind-Free panel until it comes free from the air conditioner.
- 3 Use a soft brush or vacuum cleaner to remove any dust.
- 4 Hang the Wind-Free panel in the grooves at the bottom left and right.
- 5 Align the projections of the Wind-Free panel with the grooves at the top, middle, and bottom of the front panel.
- 6 After inserting the Wind-Free panel, press the top 4 places and the bottom 3 places by hand so that there is no gap to the panel.

CAUTION

- If you attach the Wind-Free panel without the airflow blade being open, it may become obstructed by the Wind-Free panel and may not open properly.



Maintaining the Air Conditioner

If the air conditioner will not be used for an extended period of time, dry the air conditioner to maintain in best conditions.

- 1 Dry the air conditioner thoroughly by operating in Fan mode for 3 to 4 hours and disconnect the power plug. There may be internal damage if moisture is left in components.
- 2 Before using the air conditioner again, dry the inner components of the air conditioner again by running in Fan mode for 3 to 4 hours. This helps remove odours that may have generated from dampness.

Periodical checks

Refer to the following chart to maintain the air conditioner properly.

Type	Description	Monthly	Every 4 months	Once a year
Indoor unit	Clean the air filter (1).	●		
	Clean the condensate drain pan (2).			●
	Thoroughly clean the heat exchanger (2).			●
	Clean the condensate drain pipe (2).		●	
	Replace the remote control batteries (1).			●
Outdoor unit	Clean the heat exchanger on the outside of the unit (2).		●	
	Clean the heat exchanger on the inside of the unit (2).			●
	Clean the electric components with jets of air (2).			●
	Verify that all the electric components are firmly tightened (2).			●
	Clean the fan (2).			●
	Verify that all the fan assembly is firmly tightened (2).			●
	Clean the condensate drain pan (2).			●

NOTE

- The checks and maintenance operations described above are essential to guarantee the efficiency of the air conditioner. The frequency of these operations may vary depending on the characteristics of the area, the amount of dust, etc.
 - a. The above mentioned operations should be performed more frequently if the area of installation is very dusty.
 - b. These operations must always be performed by qualified personnel. For more detailed information, refer to Installation Manual.





Maintaining the Air Conditioner

Internal protections via the unit control system

This internal protection operates if an internal fault occurs in the air conditioner.

Type	Description
Against cold air	The internal fan will be off against cold air when the heat pump is heating.
De-ice cycle	The internal fan will be off against cold air when the heat pump is heating.
Anti-protection of internal battery	The compressor will be off to protect internal battery when the air conditioner operates in Cool mode.
Protect compressor	The air conditioner does not start operating immediately to protect the compressor of the outdoor unit after it has been started.

NOTE

- If the heat pump is operating in Heat mode, the de-ice cycle is actuated to remove frost from an outdoor unit that may have deposited at low temperatures.
- The internal fan is switched off automatically and restarted only after the de-ice cycle is completed.
- When the de-ice cycle is operating, it may generate strange sound. It is normal operation for product safety.





Troubleshooting

If the air conditioner operates abnormally, refer to the following chart to save time and unnecessary expenses.

Problem	Solution
<p>The air conditioner does not work at all.</p>	<ul style="list-style-type: none"> • Check the power status, then operate the air conditioner again. • Switch on the circuit breaker, plug in the power cord, then operate the air conditioner again. • Make sure that the isolator is turned on. • Check whether the Timed off function is running. Operate the air conditioner again by pressing the Power button.
<p>I cannot change the temperature.</p>	<ul style="list-style-type: none"> • Check whether the Fan or Fast mode is running. In these modes, the air conditioner controls the set temperature automatically, and you cannot change the set temperature.
<p>Cool/Warm air does not come out the air conditioner or performance is reduced.</p>	<ul style="list-style-type: none"> • Check whether the set temperature is higher in the Cool mode or lower in the Heat mode than the current temperature. Press the Temperature button on the remote control to change the set temperature. • Check whether the air filter is blocked with dirt. If the air filter is blocked, the cooling and heating performance may decrease. Remove dirt regularly. • Check if the outdoor unit is covered or installed near the obstacle. Take the cover off and take the obstacle away. When clearing the obstacle (e.g. snow or ice), use suitable tools so as to be careful not to damage the product nor injure yourself during this process. • Check whether the air conditioner is running the defrost function. When ice forms in winter or the outdoor temperature is too low, the air conditioner runs the defrost function automatically. While this function is running, the indoor fan stops and warm air does not come out. • Check whether doors or windows are open. This may cause poor cooling or heating performance. Close the doors and windows. • Check whether the air conditioner is turned on immediately after the cooling or heating operation stops. In this case, only the fan runs to protect the outdoor unit compressor. • Check whether the pipe length is too long. When the pipe length exceeds the maximum pipe length, the cooling and heating performance may decrease.





Troubleshooting

Problem	Solution
I cannot change the air flow direction.	<ul style="list-style-type: none"> When the Auto, Dry, or Fast mode is running or the good'sleep function is running in the Cool mode, the air conditioner controls the fan speed automatically and you cannot change the fan speed.
I cannot change the fan speed.	<ul style="list-style-type: none"> Check if the unit is in Auto, Dry, or Fast mode or the good'sleep function is on in Cool mode. In these conditions, you cannot control the fan speed; the unit automatically controls the fan speed.
The remote control does not work.	<ul style="list-style-type: none"> Replace the batteries in the remote control with new ones. Make sure that nothing is blocking the remote control sensor. Check whether there are strong lighting apparatus near the air conditioner. Strong light which comes from fluorescent bulbs or neon signs may interrupt the electric waves.
The Timed on/off function does not work.	<ul style="list-style-type: none"> Check whether you pressed the SET button on the remote control after setting the time.
The indicator blinks continuously.	<ul style="list-style-type: none"> Press the Power button to turn off the air conditioner or disconnect the power plug. If the indicator is still blinking, contact the service centre.
Odours permeate in the room during operation.	<ul style="list-style-type: none"> Check whether the air conditioner is running in a smoky area. Ventilate the room or operate the air conditioner in the Fan mode for 3 to 4 hours. (There are no components used in the air conditioner that emit a strong odour.) Check whether the drains are clean. Clean them regularly.
An error is indicated.	<ul style="list-style-type: none"> If the indoor unit indicator blinks, contact the nearest service centre. Be sure to pass the error code to the service centre.





Problem	Solution
Noise is generated.	<ul style="list-style-type: none">When refrigerant flow changes, noise may be generated, depending on the status of the air conditioner. This is a normal operation.
'Excessive Noise is Generated' and 'Reduced Performance'	<ul style="list-style-type: none">If excessive/irregular noise is generated in conjunction with reduced product performance, please refer to your service engineer to ensure the product is operating correctly.
Smoke is generated from the outdoor unit.	<ul style="list-style-type: none">If may not be a fire but it can be a steam generated from the outdoor heat exchanger while the defrost function is running in the Heat mode in winter.
Water drops from the pipe connections of the outdoor unit.	<ul style="list-style-type: none">Condensation may develop when the ambient temperature changes excessively. This is a normal operation.



Operation Ranges

The table below indicates the temperature and humidity ranges the air conditioner can be operated within. Refer to the table for efficient use.

Model	MODE	OPERATIONAL TEMPERATURE		INDOOR HUMIDITY
		INDOOR	OUTDOOR	
AC026TNXDKG AC035TNXDKG	Cool	18°C to 32°C	-15°C to 46°C	80% or less
	Heat	30°C or less	-20°C to 24°C	-
	Dry	18°C to 32°C	-15°C to 46°C	80% or less
AC052TNXDKG AC071TNXDKG	Cool	18°C to 32°C	-15°C to 50°C	80% or less
	Heat	30°C or less	-20°C to 24°C	-
	Dry	18°C to 32°C	-15°C to 50°C	80% or less

NOTE

- The standardized temperature for heating is 7 °C. If the outdoor temperature drops to 0 °C or below, the heating capacity can be reduced depending on the temperature condition.
- If the cooling operation is used at over 32 °C (indoor temperature), it does not cool at its full capacity.

Information about Refrigerant

Important information: regulation regarding the refrigerant used

This product contains fluorinated greenhouse gases. Do not vent gases into the atmosphere.

CAUTION

- If the system contains 5 tCO₂e or more of fluorinated greenhouse gases, it must be checked for leakage at least once every 12 months, according to regulation No. 517/2014. This activity must be covered by qualified personnel only. In the case of the situation above, the installer (or authorized person with responsibility for final check) must provide a maintenance book, with all the information recorded, according to REGULATION (EU) No. 517/2014 OF THE EUROPEAN PARLIAMENT AND OF THE COUNCIL of 16 April 2014 on fluorinated greenhouse gases.

Refrigerant type	GWP value
R-32	675

- GWP: Global Warming Potential
- Calculating tCO₂e: kg x GWP/1000



Technical Specifications

Type	Model	Net weight (kg)	Net dimension (W x D x H) (mm)
Indoor unit	AC026TNXDKG	9.1	820 x 299 x 215
	AC035TNXDKG	9.1	820 x 299 x 215
	AC052TNXDKG	11.5	1055 x 299 x 215
	AC071TNXDKG	12.2	1055 x 299 x 215



SAMSUNG

QUESTIONS OR COMMENTS?

COUNTRY	CALL	OR VISIT US ONLINE AT
UK	0333 000 0333	www.samsung.com/uk/support
IRELAND (EIRE)	0818 717100	www.samsung.com/ie/support
GERMANY	06196 77 555 77	www.samsung.com/de/support
FRANCE	01 48 63 00 00	www.samsung.com/fr/support
ITALIA	800-SAMSUNG (800.7267864)	www.samsung.com/it/support
SPAIN	91 175 00 15	www.samsung.com/es/support
PORTUGAL	808 207 267	www.samsung.com/pt/support
LUXEMBURG	261 03 710	www.samsung.com/be_fr/support
NETHERLANDS	088 90 90 100	www.samsung.com/nl/support
BELGIUM	02-201-24-18	www.samsung.com/be/support (Dutch) www.samsung.com/be_fr/support (French)
NORWAY	21629099	www.samsung.com/no/support
DENMARK	707 019 70	www.samsung.com/dk/support
FINLAND	030-6227 515	www.samsung.com/fi/support
SWEDEN	0771 726 786	www.samsung.com/se/support
POLAND	801-172-678* lub +48 22 607-93-33* Specjalistyczna infolinia do obsługi zapytań dotyczących telefonów komórkowych: 801-672-678* * (opłata według taryfy operatora)	http://www.samsung.com/pl/support/
HUNGARY	0680SAMSUNG (0680-726-7864)	www.samsung.com/hu/support
AUSTRIA	0800 72 67 864 (0800-SAMSUNG)	www.samsung.com/at/support
SWITZERLAND	0800 726 786	www.samsung.com/ch/support (German) www.samsung.com/ch_fr/support (French)
CZECH	800 - SAMSUNG (800-726786)	www.samsung.com/cz/support
SLOVAKIA	0800 - SAMSUNG (0800-726 786)	www.samsung.com/sk/support
CROATIA	072 726 786	www.samsung.com/hr/support
BOSNIA	055 233 999	www.samsung.com/support
North Macedonia	023 207 777	www.samsung.com/mk/support
MONTENEGRO	020 405 888	www.samsung.com/support
SLOVENIA	080 697 267 (brezplačna številka)	www.samsung.com/si/support
SERBIA	011 321 6899	www.samsung.com/rs/support
KOSOVO	0800 10 10 1	www.samsung.com/support
ALBANIA	045 620 202	www.samsung.com/al/support
BULGARIA	*3000 Цена на един звазок за разговор 0800 111 31 Безплатен за всички оператори	www.samsung.com/bg/support
ROMANIA	*8000 (apel în rețea) 08008-726-78-64 (08008-SAMSUNG) Apel GRATUIT Atenție: Dacă efectuați apelul din rețeaua Digi (RCS/ RDS), vă rugăm să ne contactați formând numărul Telverde fără ultimele două cifre, astfel: 0800872678.	www.samsung.com/ro/support
CYPRUS	8009 4000 only from landline, toll free	www.samsung.com/gr/support
GREECE	80111-SAMSUNG (80111 726 7864) only from land line (+30) 210 6897691 from mobile and land line	
LITHUANIA	8-800-77777	www.samsung.com/lt/support
LATVIA	8000-7267	www.samsung.com/lv/support
ESTONIA	800-7267	www.samsung.com/ee/support

SAMSUNG ELECTRONICS CO., LTD.

313 Moo 1 Sukhaphiban 8 Rd Sriracha Industry Park T.Bung A.Sriracha Chonburi Thailand

Samsung Electronics

Service Department

PO Box 12987, Blackrock, Co. Dublin. Ireland

or

Blackbushe Business Park, Yateley, GU46 6GG. UK